



KILLARK®

DIE CAST ALUMINUM CONDUIT OUTLET BODIES, COVERS AND GASKETS

APPLICATIONS

- Act as pull outlets for conductors being installed
- Provide openings for making splices and taps in conductors
- Act as mounting outlets for lighting fixtures
- Connect conduit sections
- Provide taps for branch conduit runs
- Make 90° bends in conduit runs
- Provide for access to conductors for maintenance and future system changes

FEATURES/BENEFITS

- Die cast copper-free aluminum construction is lightweight and corrosion resistant for long reliable service
- Epoxy powder coat finish provides additional corrosion resistance and an aesthetically pleasing appearance
- Conduit bodies are supplied up to 2" trade size as a combination body (threaded and with set screws for use with EMT or Rigid/IMC conduit)
- Pre-packaged with conduit bodies/covers/gaskets as a K-PAK® unit

STANDARD MATERIALS/FINISHES

- Bodies - Copper-free aluminum with epoxy powder paint
- Covers - Aluminum with stainless steel screws, natural finish
- Gaskets - Neoprene

**New Combination
Fittings for use
with EMT or
Rigid/IMC Conduit**



Combination fittings
Country of Origin



USA

SERIES CO (for EMT or RIGID/IMC) and SERIES TWO (EMT only)

Die Cast Aluminum Conduit Outlet Bodies, Covers and Gaskets



C Type - COC-1,2,3



LB Type - COLB-1,2,3

K-PAK®

Unit Packaging
Body/Cover/Gasket



C Type - COC-4,5,6



LB Type - COLB-4,5,6

UL Listed

SF Certified

FEATURES-SPECIFICATIONS

Applications

To provide access to conductors for pulling, splicing, maintenance, and for future changes or upgrades. Combination bodies (1/2" - 2") for use with EMT or Rigid/IMC conduit. Sizes 2-1/2 and larger for use with EMT only (not threaded).

Features

- Combination bodies have threaded and set screw hubs
- Pre-packaged with body, cover and gasket.
- Covers furnished with stainless steel screws

Material/Finish

Conduit Bodies - Die cast, copper-free aluminum (less than 4/10 of 1%) with electrostatically applied powder coating.

Covers - Stamped Aluminum/Natural Finish

Gaskets - Neoprene

C TYPE CONDUIT BODY										
CATALOG NUMBER	HUB SIZE	DIMENSIONS							VOLUME CU. IN.	
		A	B	C	D	E	F	G		
C	COC-1CG	1/2"	5-3/8" (137)	1-3/8" (35)	1-3/8" (35)	1" (25)	3-5/32" (80)	—	5/8" (16)	4.0
O	COC-2CG	3/4"	6-1/8" (156)	1-5/8" (41)	1-5/8" (67)	1-7/32" (31)	3-25/32" (96)	—	3/4" (19)	7.0
M	COC-3CG	1"	7-1/8" (181)	2" (51)	1-7/8" (48)	1-15/32" (37)	4-17/32" (115)	—	15/16" (24)	12.0
B	COC-4CG	1-1/4"	9-1/8" (232)	2-5/8" (67)	2-5/8" (67)	2" (51)	6" (152)	—	1-3/16" (30)	32.0
O	COC-5CG	1-1/2"	9-1/4" (235)	2-3/4" (70)	2-5/8" (67)	2" (51)	6" (152)	—	1-3/8" (32)	36.0
E	COC-6CG	2"	11-7/8" (302)	3-1/2" (89)	3-1/8" (79)	2-9/16" (65)	8-1/16" (205)	—	1-5/8" (38)	70.0
M	TWOC-7CG	2-1/2"	15-1/8" (384)	4" (102)	4-3/8" (111)	3-11/16" (94)	10-5/8" (270)	—	1-13/16" (30)	153.0
T	TWOC-8CG	3"	15-1/8" (384)	4-3/4" (121)	4-3/8" (111)	3-11/16" (94)	10-5/8" (270)	—	2-3/16" (54)	181.0
	TWOC-9CG	3-1/2"	18-3/8" (467)	5-1/2" (140)	5-1/2" (140)	4-7/8" (124)	13-1/8" (333)	—	2-1/2" (67)	290.0
	TWOC-0CG	4"	18-3/8" (467)	5-5/8" (143)	5-1/2" (140)	4-7/8" (124)	13-1/8" (333)	—	2-3/4" (67)	320.0

Dimensions

C Type

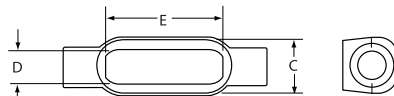
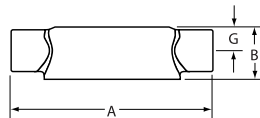

LB Type

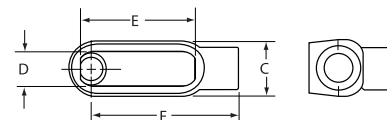
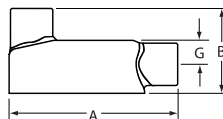

KILLARK®

LB TYPE CONDUIT BODY										
CATALOG NUMBER	HUB SIZE	DIMENSIONS							VOLUME CU. IN.	
		A	B	C	D	E	F	G		
C	COLB-1CG	1/2"	4-17/32" (115)	2-9/32" (83)	1-3/8" (35)	1" (25)	3-5/32" (80)	4-3/8" (111)	5/8" (16)	4.0
O	COLB-2CG	3/4"	5-3/4" (146)	2-1/2" (64)	1-5/8" (41)	1-7/32" (31)	3-25/32" (96)	4-29/32" (125)	3/4" (19)	7.0
M	COLB-3CG	1"	6-5/8" (168)	2-29/32" (74)	1-7/8" (48)	1-15/32" (37)	4-17/32" (115)	5-23/32" (145)	15/16" (24)	12.0
B	COLB-4CG	1-1/4"	7-1/2" (191)	3-3/16" (81)	2-5/8" (67)	2" (51)	6" (152)	6-13/32" (162)	1-3/16" (30)	28.8
O	COLB-5CG	1-1/2"	9-1/8" (232)	4" (102)	2-5/8" (67)	2" (51)	6" (152)	17-3/4" (451)	1-3/8" (32)	36.0
E	COLB-6CG	2"	10" (254)	4-13/16" (122)	3-1/8" (79)	2-9/16" (65)	8-1/16" (205)	8-5/32" (207)	1-5/8" (38)	70.0
M	TWOLB-7CG	2-1/2"	13-15/16" (354)	6-1/8" (156)	4-3/8" (111)	3-11/16" (94)	10-5/8" (270)	11-7/16" (291)	2-1/2" (64)	142.0
T	TWOLB-8CG	3"	13-15/16" (354)	6-1/2" (165)	4-3/8" (111)	3-11/16" (94)	10-5/8" (270)	11-7/16" (291)	2-3/16" (54)	173.0
	TWOLB-9CG	3-1/2"	16-7/8" (429)	7-9/16" (192)	5-1/2" (140)	4-7/8" (124)	13-1/8" (333)	13-3/4" (349)	2-1/2" (67)	292.0
	TWOLB-0CG	4"	16-7/8" (429)	7-13/16" (198)	5-1/2" (140)	4-7/8" (124)	13-1/8" (333)	13-3/4" (349)	2-3/4" (70)	324.0

SERIES CO (for EMT or RIGID/IMC) and SERIES TWO (EMT only)

Die Cast Aluminum Conduit Outlet Bodies, Covers and Gaskets



LL Type - COL-1,2,3



LR Type - COLR-1,2,3

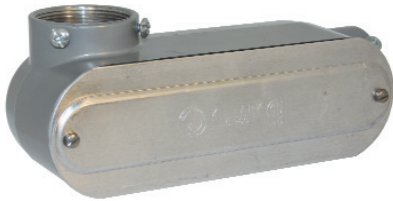

LL Type - COL-4,5,6



LR Type - COLR-4,5,6

K-PAK®

Unit Packaging
Body/Cover/Gasket

UL LISTED

SP CERTIFIED

FEATURES-SPECIFICATIONS

See inside cover page for Applications, Features and Standard Materials & Finish

Dimensions

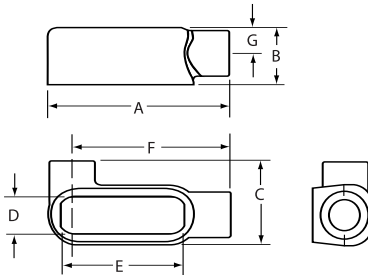

LL Type

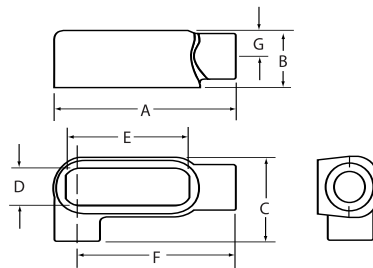

LR Type

LL TYPE CONDUIT BODY

CATALOG NUMBER	HUB SIZE	DIMENSIONS							VOLUME CU. IN.
		A	B	C	D	E	F	G	
C COLL-1CG	1/2"	4-5/8" (117)	1-3/8" (35)	2" (51)	1" (25)	3-5/32" (80)	—	5/8" (16)	4.0
O COLL-2CG	3/4"	5-3/8" (137)	1-5/8" (41)	2-3/16" (56)	1-7/32" (31)	3-25/32" (96)	—	3/4" (19)	7.0
M COLL-3CG	1"	6-1/4" (159)	2" (51)	2-9/16" (65)	1-15/32" (37)	4-17/32" (115)	—	15/16" (24)	12.0
B COLL-4CG	1-1/4"	8-1/8" (206)	2-5/8" (67)	3-1/2" (89)	2" (51)	6" (152)	—	1-3/16" (30)	32.0
O COLL-5CG	1-1/2"	8-1/8" (206)	2-3/4" (70)	3-1/2" (89)	2" (51)	6" (152)	—	1-3/8" (32)	31.0
E COLL-6CG	2"	10-9/16" (268)	3-1/2" (89)	4-3/16" (106)	2-9/16" (65)	8-1/16" (205)	—	1-5/8" (38)	70.0
M TWOLL-7CG	2-1/2"	13-11/16" (348)	4" (102)	5-3/4" (146)	3-11/16" (94)	10-5/8" (270)	—	1-13/16" (46)	142.0
T TWOLL-8CG	3"	13-11/16" (348)	4-3/4" (121)	5-3/4" (146)	3-11/16" (94)	10-5/8" (270)	—	2-3/16" (54)	173.0
M TWOLL-9CG	3-1/2"	16-1/2" (419)	5-1/2" (140)	7-1/8" (181)	4-7/8" (124)	13-1/8" (333)	—	2-1/2" (67)	292.0
T TWOLL-0CG	4"	16-1/2" (419)	5-5/8" (143)	7-1/8" (181)	4-7/8" (124)	13-1/8" (333)	—	2-3/4" (67)	324.0

LR TYPE CONDUIT BODY

CATALOG NUMBER	HUB SIZE	DIMENSIONS							VOLUME CU. IN.
		A	B	C	D	E	F	G	
C COLR-1CG	1/2"	4-5/8" (117)	1-3/8" (35)	2" (51)	1" (25)	3-5/32" (80)	4-3/8" (111)	5/8" (16)	4.0
O COLR-2CG	3/4"	5-3/8" (137)	1-5/8" (41)	2-3/16" (56)	1-7/32" (31)	3-25/32" (96)	4-29/32" (125)	3/4" (19)	7.0
M COLR-3CG	1"	6-1/4" (159)	2" (51)	2-9/16" (65)	1-15/32" (37)	4-17/32" (115)	5-23/32" (145)	15/16" (24)	12.0
B COLR-4CG	1-1/4"	8-1/8" (206)	2-5/8" (67)	3-1/2" (89)	2" (51)	6" (152)	6-13/32" (162)	1-3/16" (30)	32.0
O COLR-5CG	1-1/2"	8-1/8" (206)	2-3/4" (70)	3-1/2" (89)	2" (51)	6" (152)	17-3/4" (451)	1-3/8" (32)	31.0
E COLR-6CG	2"	10-9/16" (268)	3-1/2" (89)	4-3/16" (106)	2-9/16" (65)	8-1/16" (205)	9-5/32" (233)	1-5/8" (38)	70.0
M TWOLR-7CG	2-1/2"	13-11/16" (348)	4" (102)	5-3/4" (146)	3-11/16" (93)	10-5/8" (270)	11-7/16" (291)	1-13/16" (54)	142.0
T TWOLR-8CG	3"	13-11/16" (348)	4-3/4" (121)	5-3/4" (146)	3-11/16" (93)	10-5/8" (270)	11-7/16" (291)	2-3/16" (54)	173.0
M TWOLR-9CG	3-1/2"	16-1/2" (419)	5-1/2" (140)	7-1/8" (181)	4-7/8" (124)	13-1/8" (333)	13-3/4" (349)	2-1/2" (67)	292.0
T TWOLR-0CG	4"	16-1/2" (419)	5-5/8" (143)	7-1/8" (181)	4-7/8" (124)	13-1/8" (333)	13-3/4" (349)	2-3/4" (67)	324.0

SERIES CO (for EMT or RIGID/IMC) and SERIES TWO (EMT only)

Die Cast Aluminum Conduit Outlet Bodies, Covers and Gaskets



T Type - COT-1,2,3



NEOPRENE GASKET



Unit Packaging
Body/Cover/Gasket



T Type - COT-4,5,6



ALUMINUM STAMPED COVER



FEATURES-SPECIFICATIONS

See inside cover page for Applications, Features and Standard Materials & Finish

Dimensions

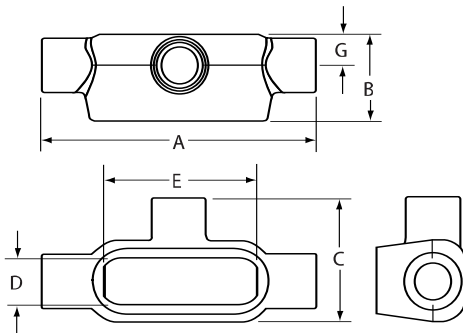

T Type

T TYPE CONDUIT BODY									
CATALOG NUMBER	HUB SIZE	DIMENSIONS							VOLUME CU. IN.
		A	B	C	D	E	F	G	
C COT-1CG	1/2"	5-3/8" (137)	1-3/8" (35)	2" (35)	1" (25)	3-5/32" (80)	—	5/8" (16)	4.0
O COT-2CG	3/4"	6-1/16" (154)	1-5/8" (41)	2-3/16" (67)	1-7/32" (31)	3-25/32" (96)	—	3/4" (19)	7.0
M COT-3CG	1"	7-1/8" (181)	2" (51)	2-9/16" (65)	1-15/32" (37)	4-17/32" (115)	—	15/16" (24)	12.0
B COT-4CG	1-1/4"	9-3/16" (233)	2-5/8" (67)	3-1/2" (89)	2" (51)	6" (152)	—	1-3/16" (30)	32.0
O COT-5CG	1-1/2"	9-3/16" (233)	2-3/4" (70)	3-1/2" (89)	2" (51)	6" (152)	—	1-3/8" (32)	33.0
E COT-6CG	2"	11-5/8" (295)	3-1/2" (89)	4-3/16" (106)	2-9/16" (65)	8-1/16" (205)	—	1-5/8" (38)	70.0
M TWOT-7CG	2-1/2"	15-1/8" (384)	4" (102)	5-3/4" (146)	3-11/16" (94)	10-5/8" (270)	—	1-13/16" (54)	142.0
T TWOT-8CG	3"	15-1/8" (384)	4-3/4" (121)	5-3/4" (146)	3-11/16" (94)	10-5/8" (270)	—	2-3/16" (54)	173.0
E TWOT-9CG	3-1/2"	18-1/8" (460)	5-1/2" (140)	7-1/8" (181)	4-7/8" (124)	13-1/8" (333)	—	2-1/2" (67)	292.0
M TWOT-0CG	4"	18-1/8" (460)	5-5/8" (143)	7-1/8" (181)	4-7/8" (124)	13-1/8" (333)	—	2-3/4" (67)	324.0

NEOPRENE REPLACEMENT GASKETS

CATALOG NUMBER	HUB SIZE
OLK-1RG	1/2"
OLK-2RG	3/4"
OLK-3RG	1"
OL-45-RG	1-1/4"
OL-45-RG	1-1/2"
OL-6-RG	2"
OL-78-RG	2-1/2"
OL-78-RG	3"
OL-90-RG	3-1/2"
OL-90-RG	4"

ALUMINUM REPLACEMENT COVERS

CATALOG NUMBER	HUB SIZE	DIMENSIONS		
		LENGTH	WIDTH	HEIGHT
OL-10	1/2"	3-15/16"(100)	1-3/8"(35)	3/8"(10)
OL-20	3/4"	4-5/8"(117)	1-5/8"(41)	3/8"(10)
OL-30	1"	5-3/8"(137)	1-7/8"(48)	5/8"(16)
OL-450	1-1/4"	7-3/16"(183)	2-5/8"(67)	5/8"(16)
OL-450	1-1/2"	7-3/16"(183)	2-5/8"(67)	5/8"(16)
OL-60	2"	9-1/2"(241)	3-1/8"(79)	5/8"(16)
OL-780	2-1/2"	12-1/4"(311)	4-3/8"(111)	5/8"(16)
OL-780	3"	12-1/4"(311)	4-3/8"(111)	5/8"(16)
OL-900	3-1/2"	14-7/8"(378)	5-1/2"(140)	5/8"(16)
OL-900	4"	14-7/8"(378)	5-1/2"(140)	5/8"(16)